



Fig. 1. Stable and low on the water, Pintail makes an ideal duck boat.

PINTAIL

Lightweight Duck Boat

By WILLIAM D. JACKSON

FEATURES: Light weight for carrying atop an auto, adapted to paddling on protected waterways. Also makes an excellent small boat for children's use.

LENGTH: 10 ft.

BEAM: 40 in. (overall)

WEIGHT: 75 lb.

SEATING CAPACITY: 1 adult or 2 children.

MATERIAL: Exterior plywood over a stressed framework.

GENERAL CONSTRUCTION: Convex bottom for extreme strength with plywood covering. Bottom can be applied in one piece. Can be built in 1 week.

Craft Print Project No. 159

AS A duck boat, *Pintail* is small and able, leakproof, light enough in weight (60 lbs.) to be handled by one man, and versatile enough to serve as a year-round fun boat for both children and adults. Begin constructing *Pintail* by first drawing a full-size paper pattern of #1 and #3 frames (they're the same pattern) and another of the #2 mold frame (Fig. 6). Also make patterns for the stem, outer stem, and cockpit knees (Fig. 10). Lay these paper patterns on the framing and stem material, prick the outlines through and saw the component parts to shape. Then reassemble the frame parts on the patterns. Mold frame #2 consists of a bottom member cut from a 2x4 and side members cut from 1x4's; these are sawed so they fit flush into the 2x4 bottom member and then joint nailed together. This mold shapes the hull during construction and is removed after hull is planked. After frames #1 and #3 are cut to shape, fasten chine joints together with $\frac{1}{4}$ in. plywood gussets, one on each side of the joint or 4 gussets to each frame. To fasten, first coat contact surfaces of frame and gussets with Weldwood glue and fasten gussets securely in place with galvanized shingle nails or $6 \times \frac{7}{8}$ in. *fh*

Fig. 2. Building form mounted at working height.

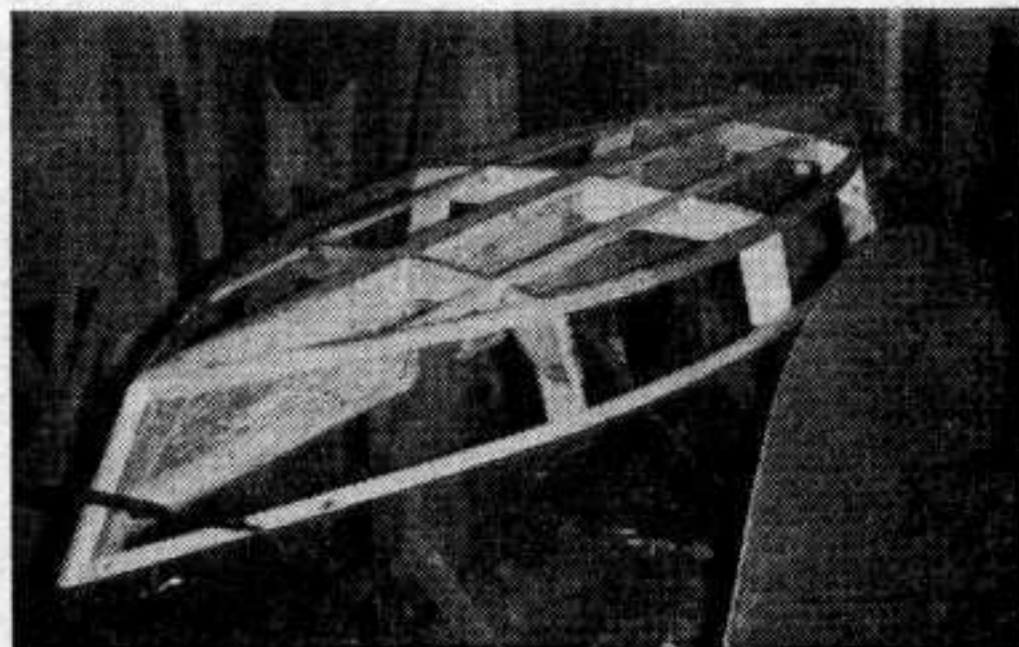

Fig. 3. Hull framing of *Pintail* complete, ready for bottom and sides.



Fig. 4. Hull with bottom complete removed from form.

screws, 4 to each joint. Make 2 deck beams as in Fig. 6 and also cut both inner and outer stems to shape; lay the deck beams and outer stems aside until later.

Next, saw form to shape (Fig. 5), and lay the bow stems in place on the form, mark around them on the form and cut the form out so these stems fit nicely in it. Then mount the form on saw-horse legs at a good working height. Now taper the keel on each side as in Fig. 5, notch all frames for the keel, chines and clamps and notch out the form to receive the frames. Mount frames on the form in their respective notches and secure the stems to the form by nailing

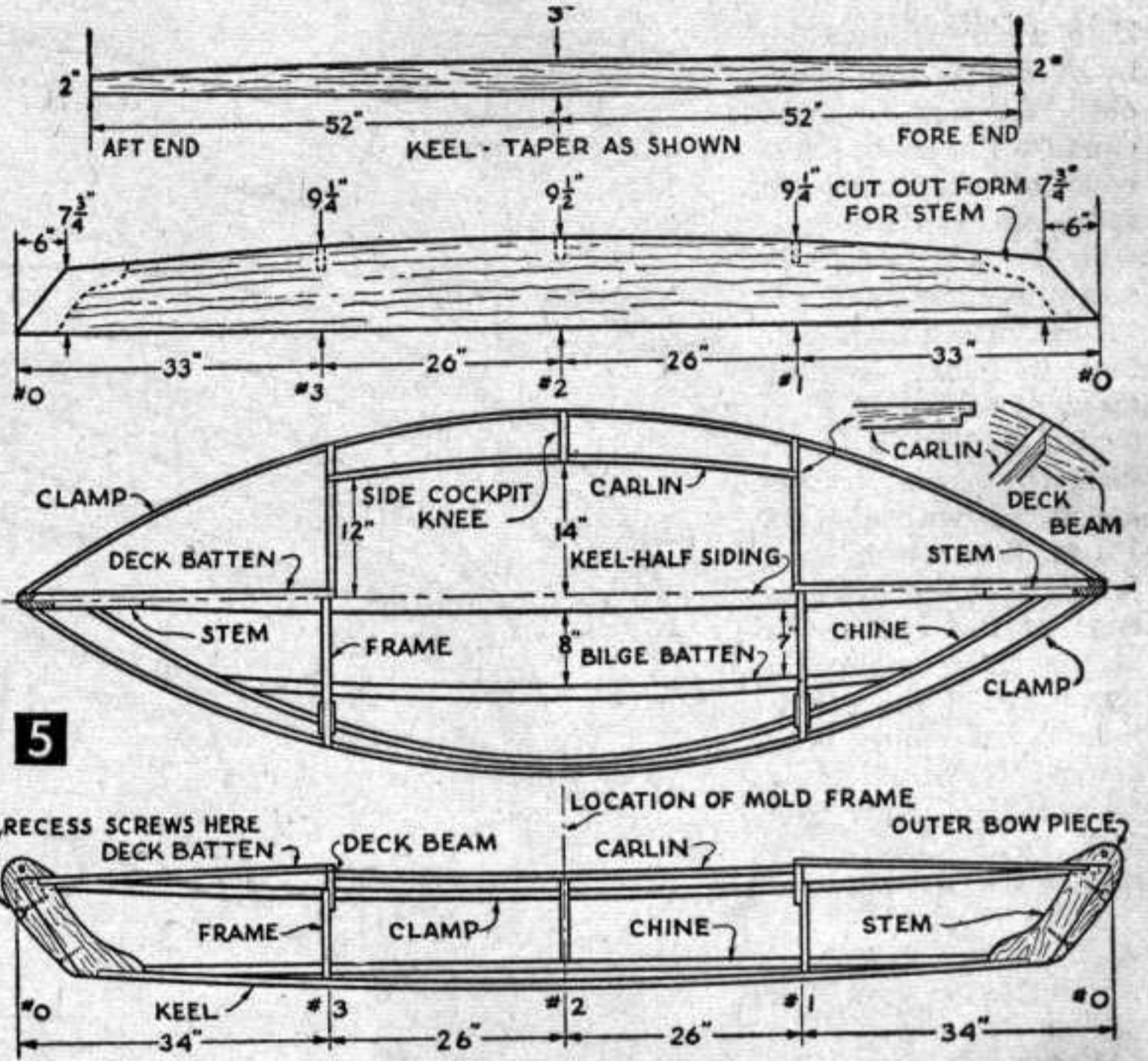

5

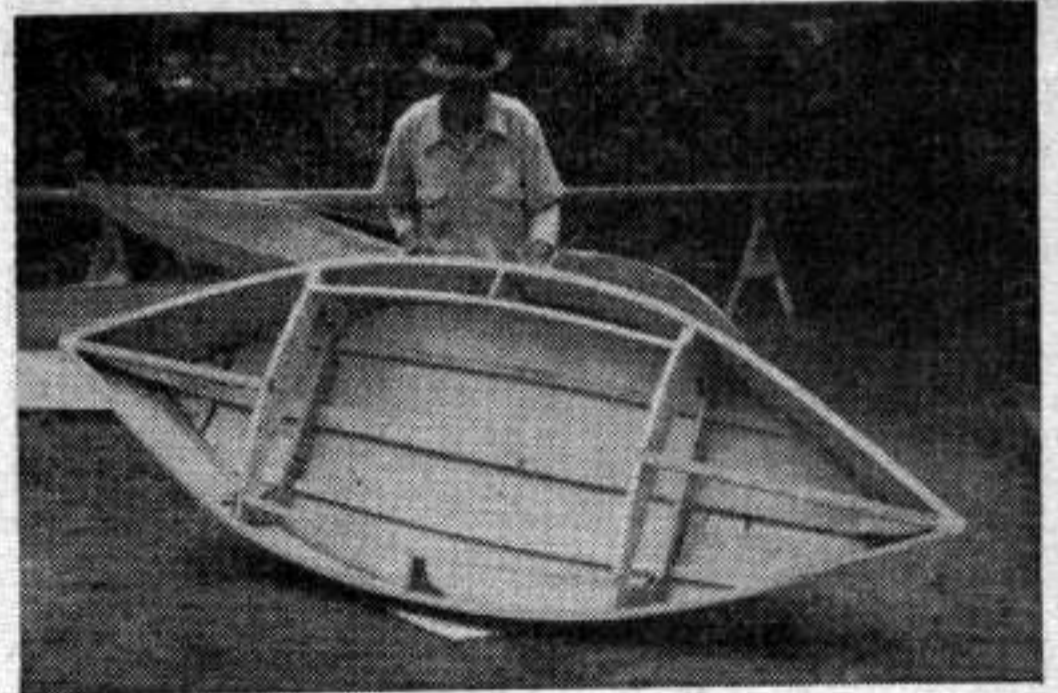
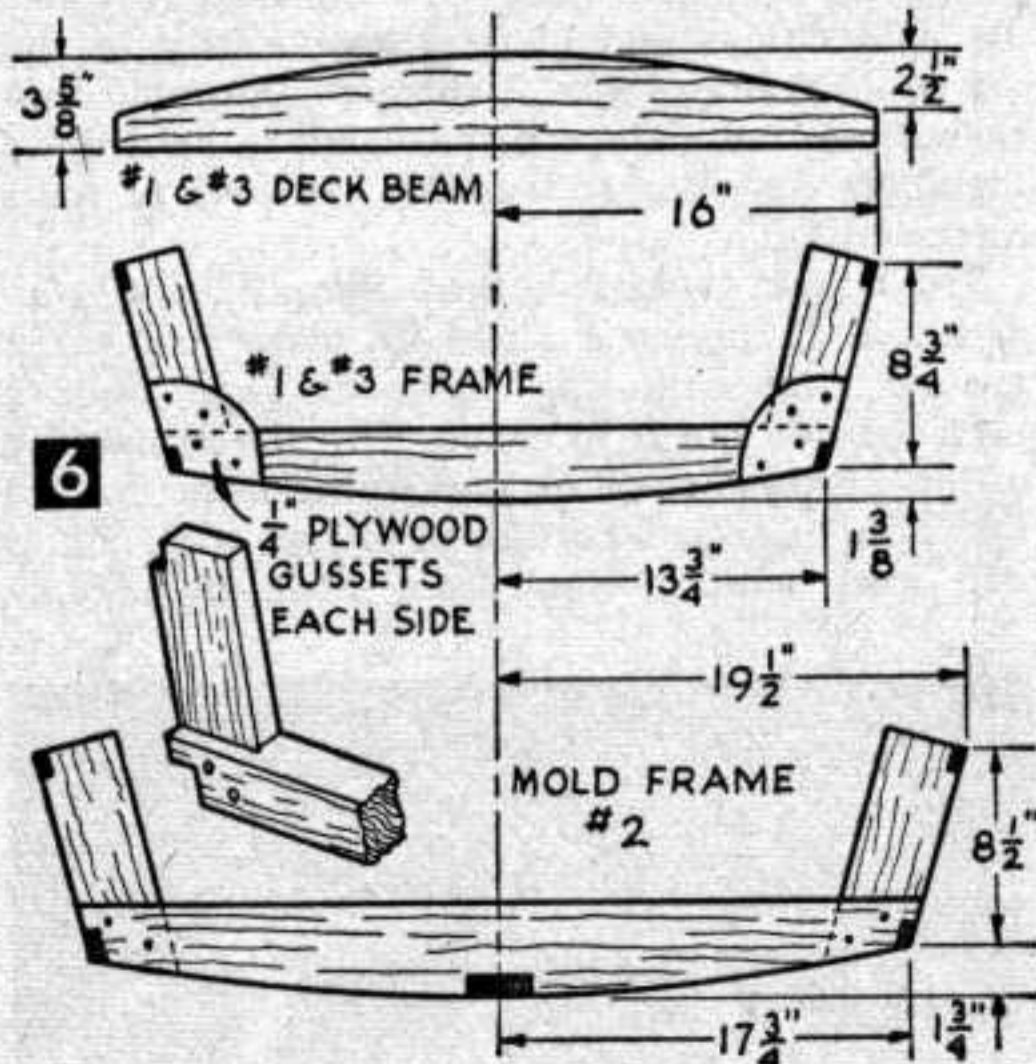

Fig. 7. Deck beams, carlins, side cockpit knee and deck battens in place.

sticks on each side of form and to the stem; these will hold stems in alignment with form during construction.

Place the keel in position and secure it to the frame notches and then to the stem notch with two 1 3/4 in. #8 fh screws to each joint. Next secure the chines in their respective notches on the frames; since this bend is a bit stout you'll need some help on this. First clamp the chines to the chine notches at #2 mold frame on each side. Now with someone at the fore end and yourself at the after end, bend chines simultaneously toward the stems and, to hold chines temporarily in place at the stem, tie ends of chines together with a piece of rope. Bevel ends of chine to fit against the stem and fasten in place with one 1 3/4 in. #8 fh screw to each joint. Then loosen ropes. Fasten opposite end in



6

like manner, bending both clamps simultaneously together so as to equalize the bend, bevel ends of clamps to fit stem and fasten each with one $1\frac{3}{4}$ in. #8 fh screw in each joint.

Next, attach bilge battens in place locating them as shown in Figs. 5 and 8. Notch them flush into the frames and fasten with one #8 $1\frac{3}{4}$ in. fh screw to each joint. Saw the extreme ends of the battens to fit the chine angle and screw fasten these battens to the chines with one #8 $1\frac{3}{4}$ in. fh screw to each joint. Now trim and fair the entire framework so plywood

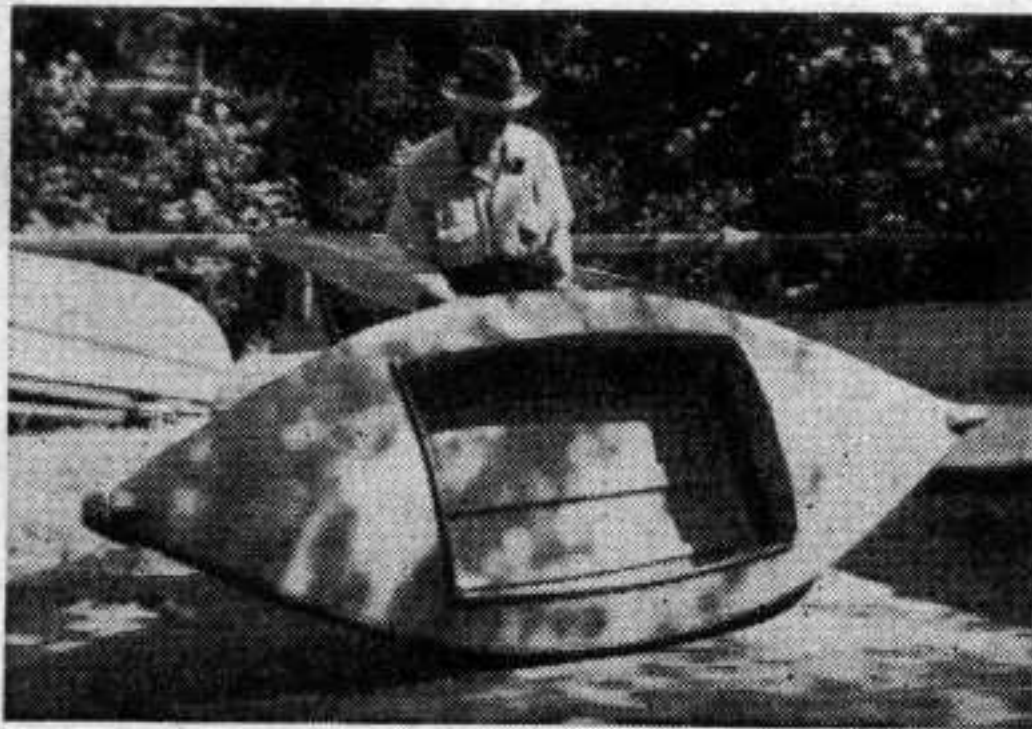
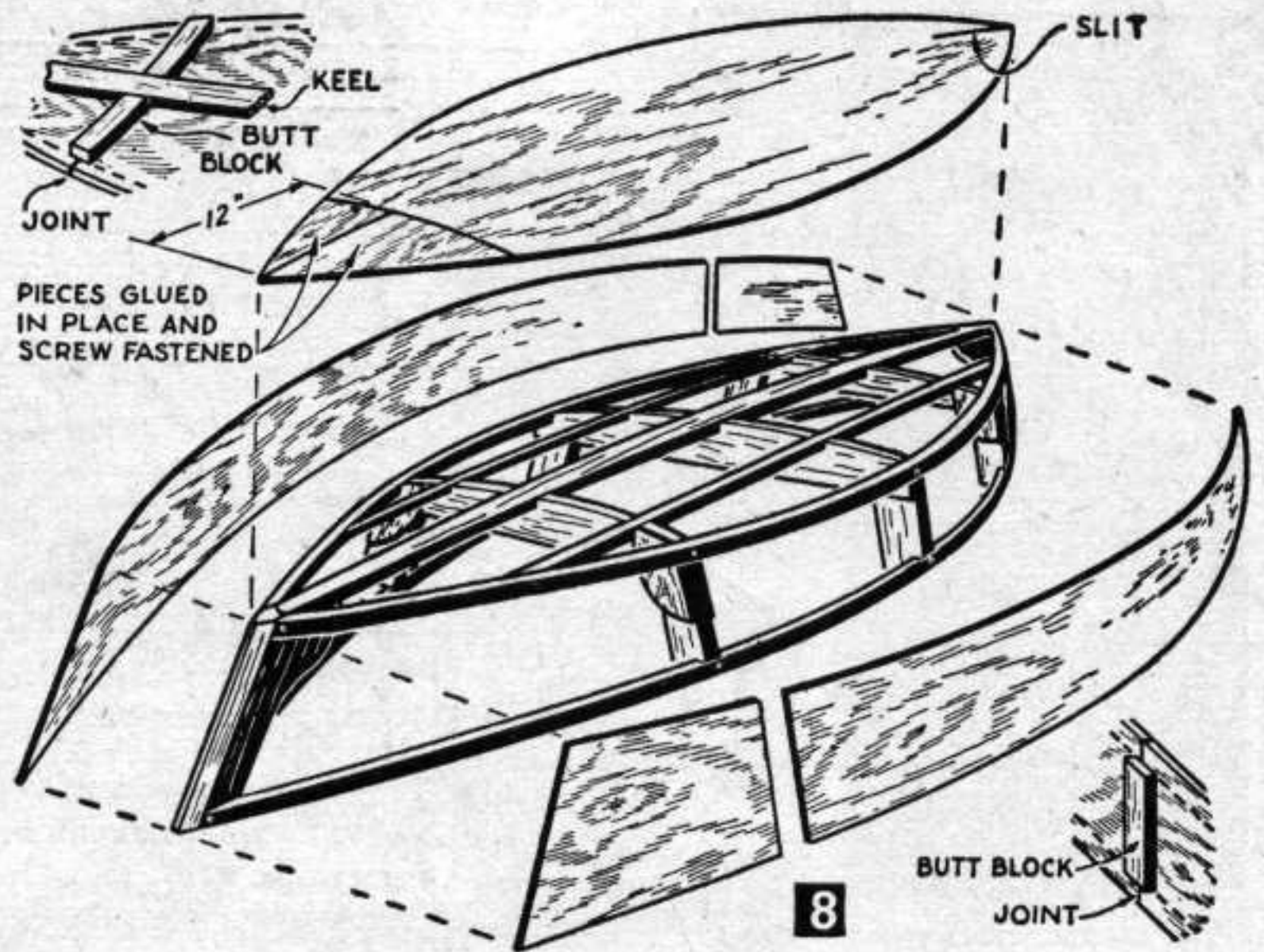

Fig. 9. Completed Pintail ready for painting and water trials.

MATERIALS LIST—PINTAIL

Exterior Plywood Required:

- 2 pcs. $\frac{1}{4}$ "x4x8' makes 1 bottom, 2 sides, floorboards & gussets
1 pc. $\frac{1}{8}$ "x4x6' or 1 pc. $\frac{1}{4}$ "x4x8' for decking

Other Lumber Required:

- | | | |
|--------|--|-------------------|
| 2 pcs. | $\frac{3}{4}$ x $1\frac{3}{8}$ "x10' | Chines |
| 1 pc. | $\frac{3}{4}$ x3"x9' | Keel |
| 1 pc. | $\frac{1}{2}$ x1"x10' | Outer keel |
| 2 pcs. | $\frac{3}{4}$ x1"x11' | Clamps |
| 2 pcs. | $\frac{3}{4}$ x $1\frac{1}{4}$ "x8' | Bilge battens |
| 1 pc. | $\frac{3}{4}$ x $3\frac{5}{8}$ x6' | Deck beams |
| 1 pc. | $\frac{3}{4}$ x3"x3' | Frames—sides |
| 1 pc. | $\frac{3}{4}$ x $3\frac{5}{8}$ "x5' | Frames—bottom |
| 1 pc. | $\frac{3}{4}$ x $3\frac{5}{8}$ "x18" | Molding—sides |
| 1 pc. | $1\frac{5}{8}$ x $3\frac{5}{8}$ "x36" | Molding—bottom |
| 1 pc. | 2x8x24" ($1\frac{5}{8}$ x7 $\frac{1}{2}$ "') | Stems |
| 1 pc. | 2x8x24" | Outer stems |
| 2 pcs. | $\frac{1}{2}$ x $\frac{3}{4}$ "x10'6" | Moldings |
| 1 pc. | $\frac{3}{4}$ x5 $\frac{1}{2}$ "x15" | Side deck support |
| 1 pc. | $\frac{3}{8}$ x5"x7' plywood, makes 2 sides 2 ends | Coaming |
| 1 pc. | 2x10"x10' (Lumber size) | Form |

Fastenings and Miscellaneous

- 3 gross $\frac{7}{8}$ " #6 fh screws or 1 lb. gal. shingle nails
2 doz. $1\frac{1}{4}$ " #8 fh screws
4 $2\frac{1}{2}$ " #12 fh screws to fasten outer stems
2 doz. $1\frac{3}{4}$ " #8 fh screws
1 pt. Kuhl's bedding composition and 1 lb. Weldwood resorcinol glue

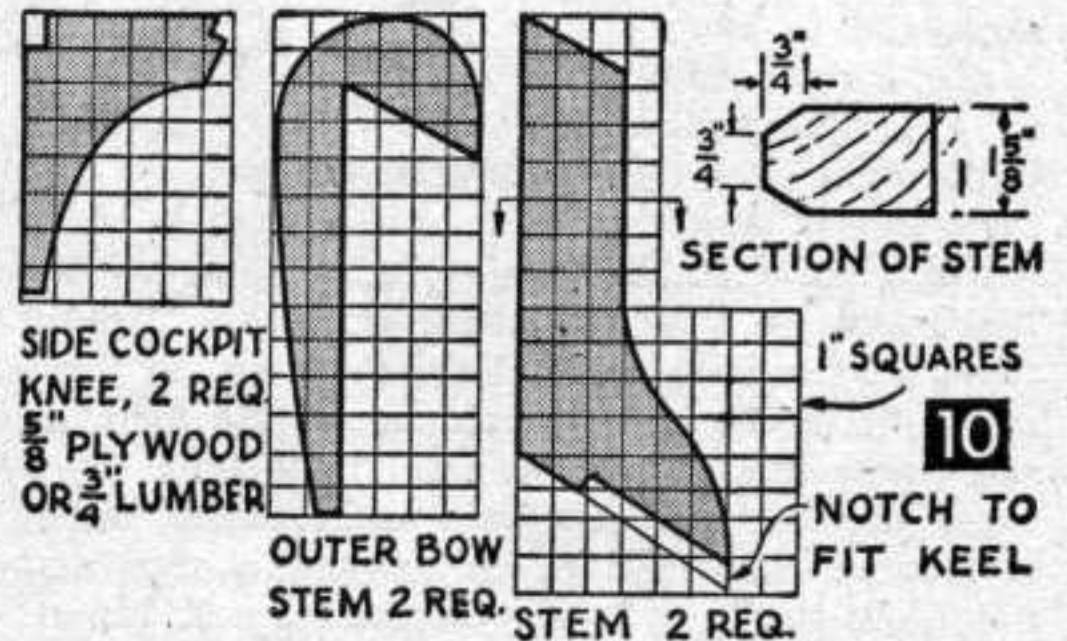

to be applied will lay evenly at all points. Use a jackplane amidships and a wood rasp forward. To hold chines and clamps temporarily to the #2 mold frame, toe nail through the mold into the chines and clamps just enough to hold these members in place and enable removal of nails afterwards.

The bottom is planked first. Simply lay a $\frac{1}{4}$ in. x 4 x 8 ft. plywood sheet in place and mark around chines on this plywood. Then remove plywood and cut it to shape. Use the remainder of this plywood to plank part of the sides. Before fastening plywood bottom in place, coat chines and keel with a waterproof resin glue. Lay



Fig. 11. Pintail mounted atop a car.

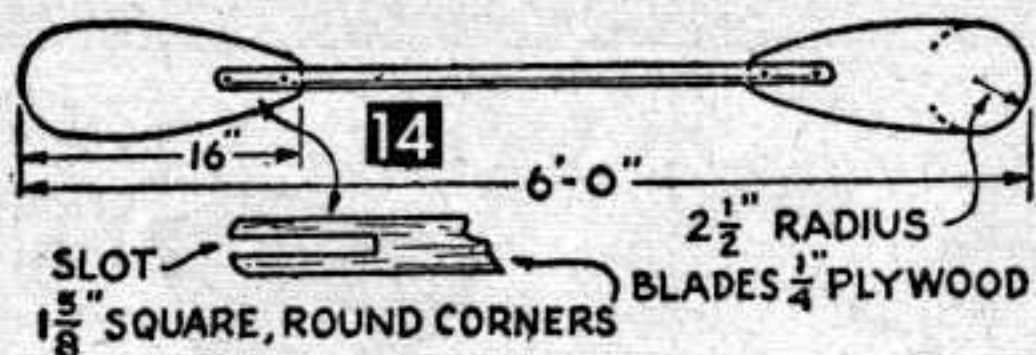
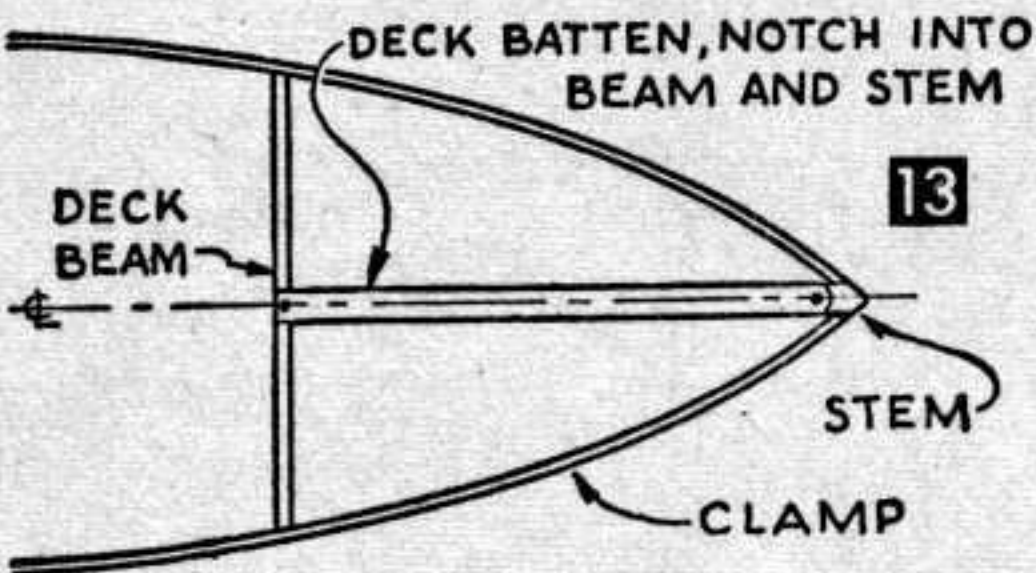
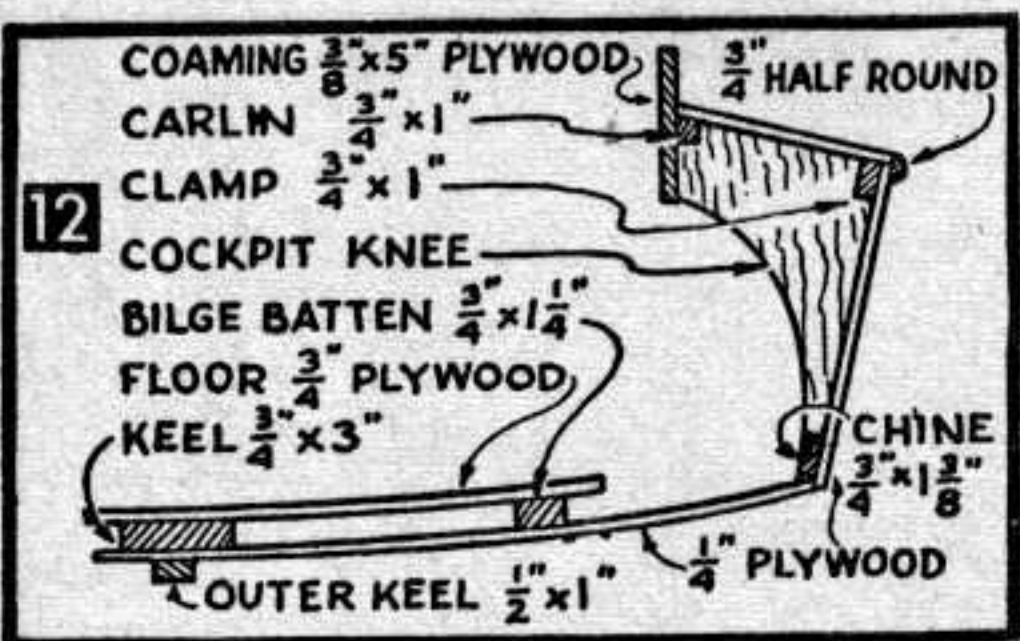

shaped bottom plywood, in position, clamp and start fastening from amidships out toward each bow along the keel first. Then fasten chines, starting from amidships and working towards each bow stem. For all planking operations, use galvanized shingle nails, aluminum nails, or #6 $\frac{7}{8}$ in. *fh* screws. Space these fastenings about 2 in. apart. To help secure the plywood bottom at the bow, first saw a slit in one end at the bow open (Fig. 8). Plank the opposite bow end with scrap ends of plywood (as in Fig. 8), gluing these joints with resin glue and furnishing a plywood batten to back the joints of planking at this end. With the bottom planked, trim the plywood edges evenly along the chines and then coat the chines liberally with Kuhl's elastic bedding composition, and the clamps with waterproof resin glue. Then clamp side planking in place and fasten along the sides as you did the bottom. When finished, trim plywood edges flush along chines and stems, remove hull from the form, turn right side up and remove #2 hold frame.

Bolt the deck beams in place with one $\frac{3}{16}$ x 2 in. *rh* stove bolt to each joint. Saw out the side deck supports (cockpit knees) as shown (Fig. 10) and screw fasten from outside the planking into these supports, using three #8 $1\frac{1}{4}$ in. *fh* screws to each support. Notch center deck battens flush into beams and stem and fasten them with #8 $1\frac{3}{4}$ in. *fh* screws, one to each joint. Then notch the carlins into the deck

beams as shown (Fig. 5) and fasten carlins to beams and side deck supports with one #8 $1\frac{3}{4}$ in. *fh* screw to each joint. Plane all joints evenly, especially along the clamps. Before decking the boat, paint inside with 2 coats of tan or gray.

Place the $\frac{1}{8}$ or $\frac{1}{4}$ in. decking plywood in position and mark and saw it to shape. Then fasten decking in place with $1\frac{1}{4}$ in. galvanized shingle nails of #6 $\frac{3}{4}$ in. *fh* screws, spaced about 3 in. apart. Trim decking edges evenly along the clamp edges and carlins and install the coamings and cockpit end coamings. These are cut to fit and screw fastened with #8 $\frac{7}{8}$ in. *fh* screws spaced about 3 in. apart. To secure the corners of the cockpit, glue pieces of $\frac{3}{4}$ -round molding into corners, tacking to hold it in place until glue dries.

Now trim the outer bow stems to fit in position (Fig. 10), coat edges of bow with bedding compo and screw-fasten outer stems in place with two #12 $2\frac{1}{2}$ in. *fh* screws to each stem (upper screw in this stem must be countersunk to hold well). Then screw fasten moldings in place with #8 $1\frac{1}{4}$ in. *fh* screws spaced about 8 in. apart. The outer keel is fastened in place with #8 $1\frac{1}{4}$ in. *fh* screws spaced about 6 in. apart. Flooring for the inside consists of a piece of $\frac{1}{4}$ in. plywood fastened to keel and bilge batts with #8 $\frac{7}{8}$ in. *fh* screws. Make the paddle shown in Fig. 14.

If this boat will be used principally for duck hunting, paint the hull a dead grass color for camouflage. For mooring while hunting ducks, bore holes through keel and deck and insert a piece of pipe, threading the end into keel and daubing liberally with caulking compound. The boat is then moored by inserting an iron rod through the pipe into the mooring grounds. This holds the boat securely and prevents movement which might scare off those water fowl.

● Craft Print No. 159 in enlarged size for building Pintail is available at \$2. Order by print number. To avoid possible loss of coin or currency in the mail, we suggest you remit by check or money order (no CODs or stamps) to Craft Print Div., SCIENCE and MECHANICS, 505 Park Ave., New York 22, N. Y. Please allow three to four weeks for delivery. Special quantity discount! If you order two or more craft prints (this or any other print), you may deduct 25¢ from the regular price of each print. Hence for two prints, deduct 50¢; three prints, subtract 75¢, etc. Now available, our new illustrated catalog of 212 do-it-yourself plans, 25¢ (refundable, first order).

Drip Cup for Oar Handle

● A hollow rubber ball can be used to prevent water from running down the oar handle when the oar is raised. Just cut the ball in half, and cut a hole slightly smaller than the oar diameter in the other end of one half. Remove the oarlock and slip the rubber drip cup on the handle.—NORM JACKY.

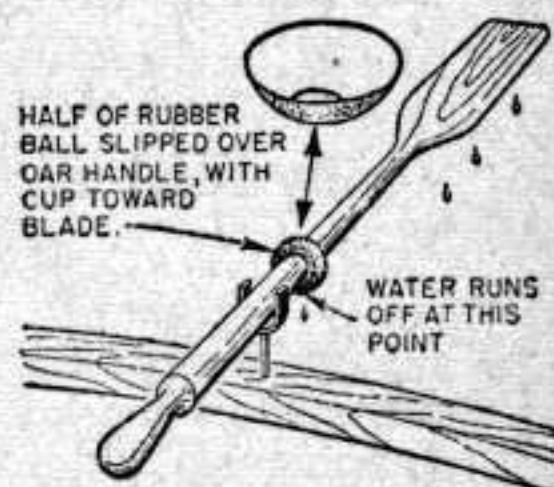



Fig. 1. Stable and low on the water, Pintail makes an ideal duck boat.

PINTAIL